

Canon



Aquilion Precision

Precision in Every Detail

Ultra-High Resolution CT

Clinical Impact of Ultra-High Resolution CT (UHR CT)

The National Cancer Center Hospital (NCC) in Central Tokyo Japan is the world authority on Ultra-High Resolution CT, having been working with prototype systems for almost a decade. To bring the NCC vision for routine application of Ultra-High Resolution CT imaging required a multitude of creative developments in computer, mechanical, chemical and electronic engineering which have come together in Ultra-High Resolution CT. The long anticipated benefits of being able to resolve anatomy at more than two times the resolution have arrived.

Pancreatic Neuro-endocrine Tumor

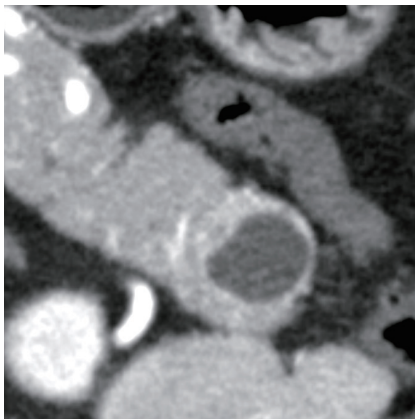

Conventional CT
(512 matrix)

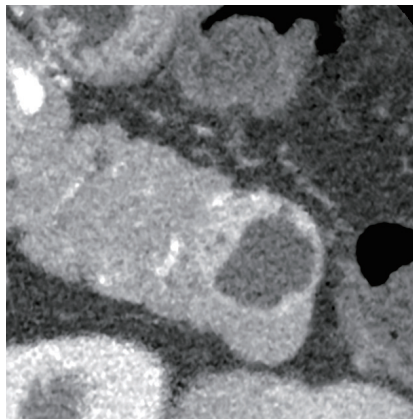

UHR CT
(1024 matrix)

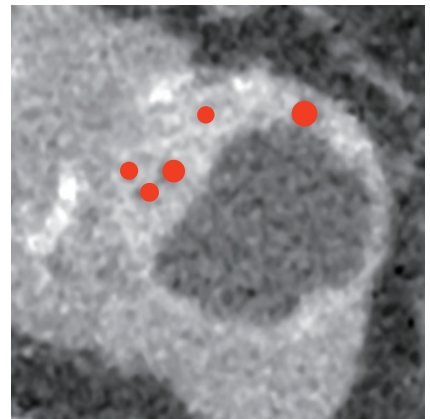

UHR CT
(1024 matrix)

Microcysts within a pancreatic neuro-endocrine tumor are clearly shown with UHR CT imaging, providing a wealth of information regarding the classification and staging of this tumor.

HR scan mode, CTDI 21.6 mGy, DLP 597.0 mGy, 9 mSv (k=0.015)

“I am seeing anatomical structures resolved in clear detail that I never thought would be possible with CT. As radiologists worldwide gain more collective experience there is an exciting future ahead for the paradigm change in imaging work-up of cancer guidelines that will become routine with Ultra-High Resolution CT.”



Dr. Miyuki Sone, MD

Consultant Radiologist, Department of Diagnostic Radiology,
National Cancer Center Hospital, Tokyo, Japan

Tumor staging in Ultra-High Resolution CT

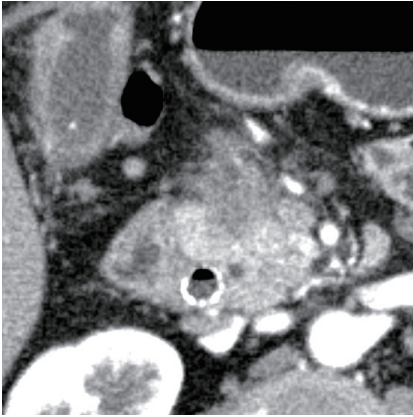

Conventional CT
(512 matrix)



UHR CT
(1024 matrix)

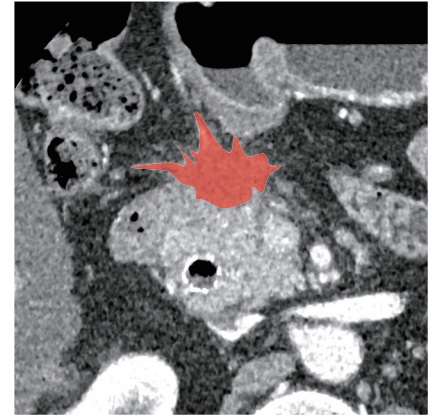

UHR CT
(1024 matrix)

Staging of pancreatic carcinoma is often difficult in CT and requires a needle biopsy leading to a poor prognosis for the patient. The detail afforded by Ultra-High Resolution CT shows the spiculated margins clearly from surrounding tissue, and provides real ability to assess for local tumor invasion with a high degree of diagnostic confidence. One giant leap in the fight to cure patients with pancreatic cancer.

SHR scan mode, CTDI 17.1 mGy, DLP 446.4 mGy, 6.7 mSv (k=0.015)

Lymphoma staging

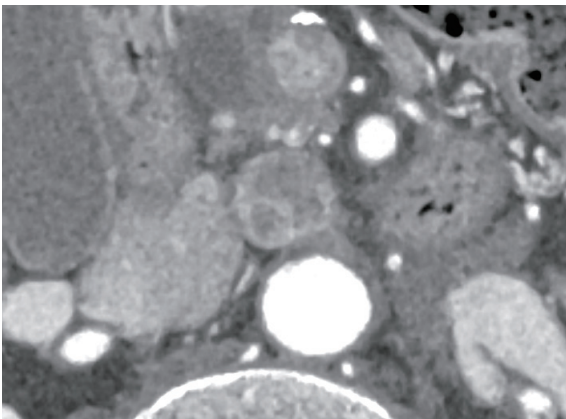

UHR CT
(1024 matrix)

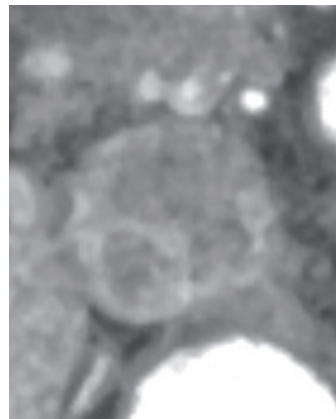

UHR CT
(1024 matrix)

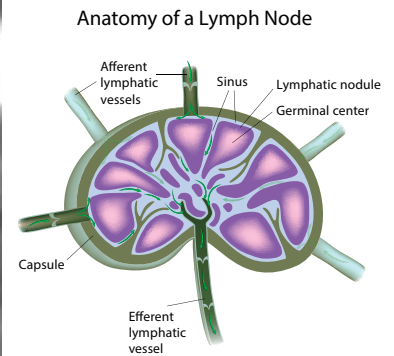

Diagram

The multiple hypo-dense structures seen within the para-aortic lymph node are lymphoid follicles, clearly shown within the internal capsule, and an important indicator in the progression of lymphoma.

HR Scan Mode, CTDI 15.5 mGy, DLP 415.5 mGy, 6.2 mSv (k=0.015)

Ultra-High Resolution CT Technology

The world's first Ultra-High Resolution CT is a truly disruptive innovation that provides diagnostic images with two times the spatial resolution compared to any modern standard resolution CT. The enormous clinical possibilities of Ultra-High Resolution CT are trending right now, with several studies under way looking at potential improvements in tumor classification and staging.

The Precision defines Ultra-High Resolution CT with a nominal 0.25 mm slice width combined with a 1792 channel detector configuration that quadruples the diagnostic information available compared to standard resolution CT. Including major advances in X-ray dose efficiency and reconstruction techniques, the Precision provides 1024 matrix images that resolve anatomy down to just 0.15 mm – or the width of a human hair.

Ultra-High Resolution CT Dose

As with any CT scan, the increased clinical benefits of Ultra-High Resolution CT must be weighed against the risks of the exposure required for the exam. A CT chest exam performed 10 years ago at 5 mSv can be performed today at 1 mSv. The same patient scanned on an Ultra-High Resolution CT scanner would receive about 1.3 mSv of dose for a chest scan resolving small anatomical details at more than two times the resolution as compared to standard resolution CT. Innovations in adaptive, iterative reconstruction techniques, including MBIR, preserve low contrast detectability at doses within standard reference ranges while simultaneously taking advantage of the high contrast spatial resolution properties made possible by 1024 matrix sizes.

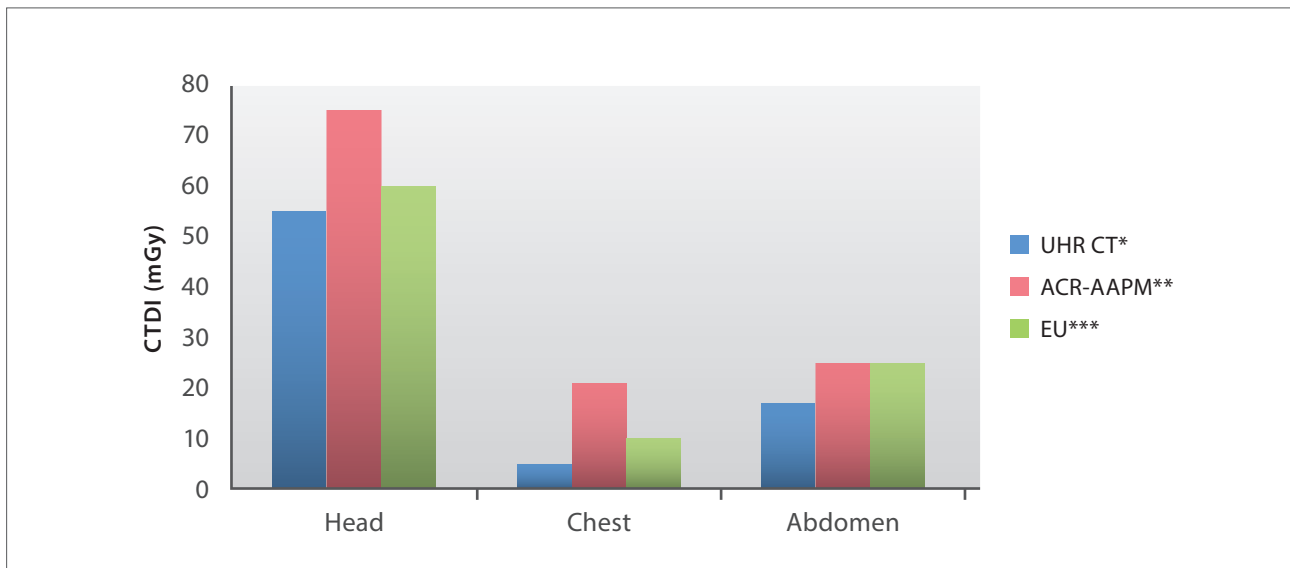

Representative doses for UHR CT compared to current Dose Reference Levels

* Examples from initial installations

** American College of Radiology (ACR). ACR-AAPM practice parameter for diagnostic reference levels and achievable doses in medical X-ray imaging. ACR website. http://www.acr.org/~media/ACR/Documents/PGTS/guidelines/Reference_Levels_Diagnostic_Xray.pdf. Published 2013. Amended 2014.

*** European Commission (EC). Radiation Protection No. 180 – Diagnostic reference levels in thirty-six European countries (Part 2/2). EC website. <https://ec.europa.eu/energy/sites/ener/files/documents/RP180%20part2.pdf>. Published 2014.

Ultra-High Resolution Detector

The Ultra-High Resolution detector contains four times the number of distinct detector elements with 160 detector rows and 1792 channels of only 0.25 mm thickness.

To deliver Ultra-High Resolution CT into routine clinical practice required a complete re-engineering of the detector manufacturing process. To maximize the geometric efficiency of the detector, the interseptal gaps between the detector elements were made much thinner, maximizing the light sensitive area on the detector. To achieve this advancement new precision cutting techniques for the creation of discrete 0.25 mm elements that could be optically isolated, permitting light transmission without cross talk, were developed. This advancement, coupled with substantial improvements in scintillator efficiency, detector circuitry and other DAS components, has resulted in the most dose efficient detector in company history. Despite doubling the number of channels and halving the row thickness, the magnitude of image noise resulting from the detector is equivalent to previous 896 channel, 0.5 mm systems.

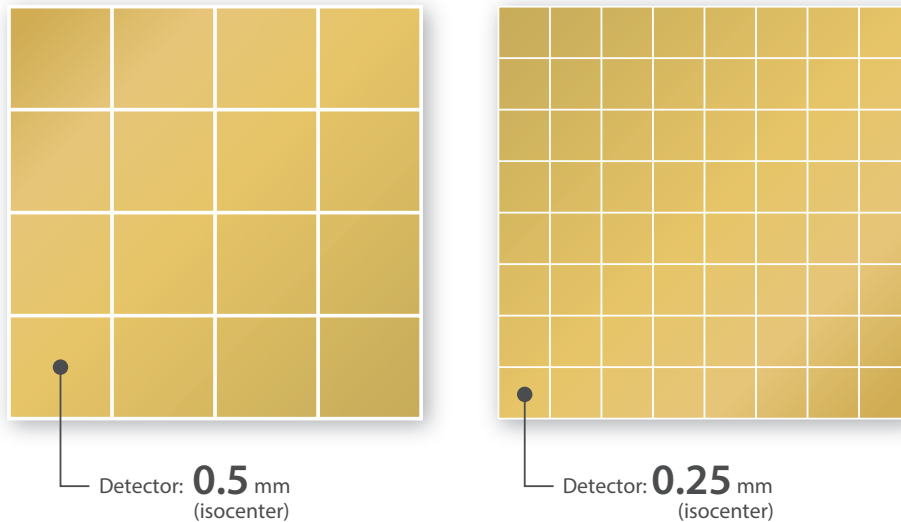

Ultra-High Resolution Tube

Ultra-High Resolution CT demands smaller focal spots be applied for the entire range of examinations. To provide this ability for all clinical needs and patient sizes an adaptive focal spot X-ray tube, capable of over six precise focal spot configurations, was designed. The tube assembly was crafted to provide high power, small focal spot X-ray generation through advances in heat dissipation and monitoring.

The anode spins at a remarkable 10,800 rpm (almost twice as fast as conventional tubes today), which combined with a liquid metal bearing provides the rapid heat dissipation necessary to guarantee fine focal size and ensure longevity.

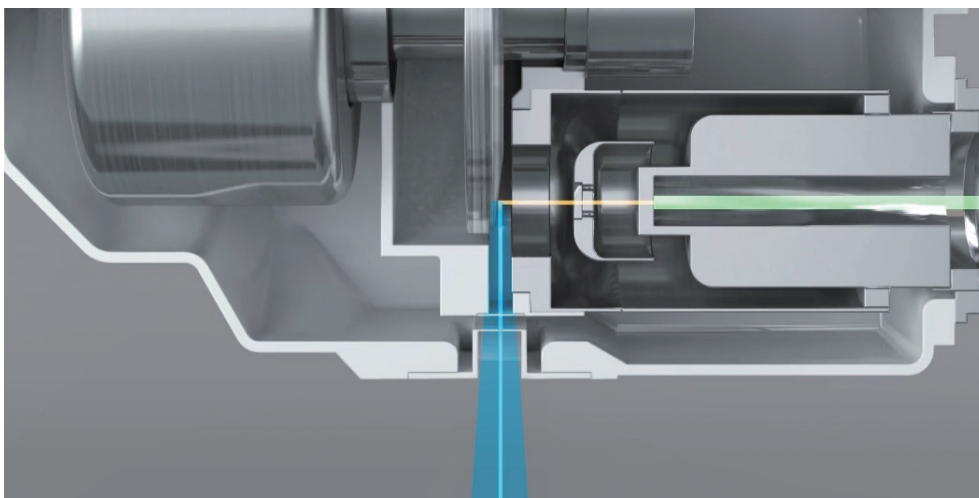

Ultra-High Resolution CT Cerebral Angiography

Small vessels in the head are clearly displayed in this high resolution CTA of the brain.

SHR Scan Mode, CTDI 53.8 mGy, DLP 1135.9 mGycm, 2.4 mSv (k=0.0021)

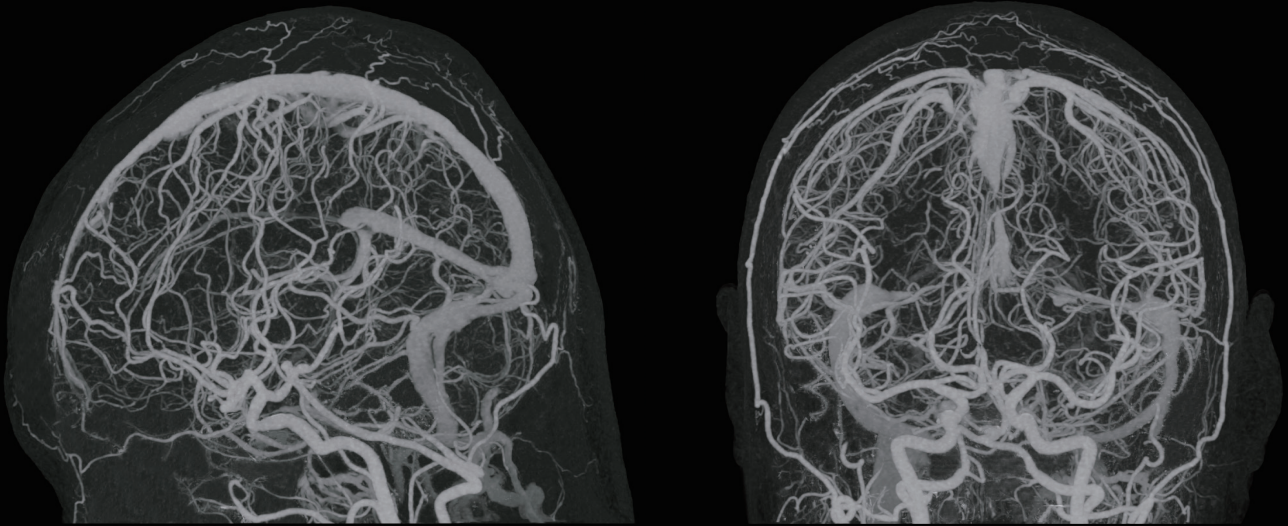

Courtesy of Fujita Health University, Japan

Ultra-High Resolution CT Ankle

Bony trabeculae are more clearly defined in the Ultra-High Resolution CT scans, providing detailed evaluation of the talus and calcaneum.

SHR Scan Mode, CTDI 6.6 mGy, DLP 179.5 mGycm



Conventional CT
(512 matrix)

UHR CT
(1024 matrix)

Courtesy of Radboud University Medical Center, the Netherlands

Ultra-High Resolution CT Chest

A carcinoma of the lung is seen in this non-contrast scan of the chest. The margins of the tumor are more clearly seen in the Ultra-High Resolution CT scan than in the conventional scan.

SHR Scan Mode, CTDI 6.2 mGy, DLP 234.8 mGycm, 3.3 mSv (k=0.014)

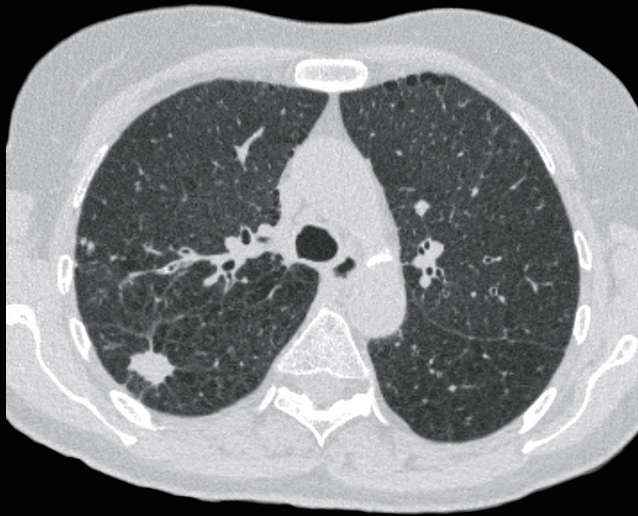

Conventional CT
(512 matrix)

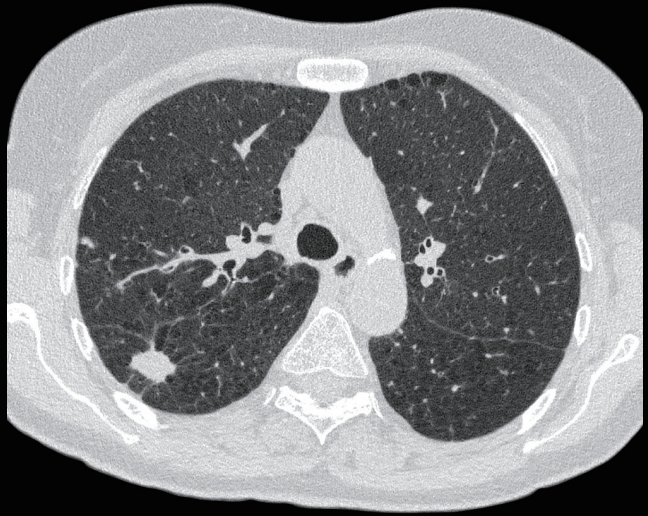

UHR CT
(1024 matrix)

Courtesy of Radboud University Medical Center, the Netherlands

Ultra-High Resolution CT Cardiac Stent

2.75 mm Cardiac Stent encased in an acrylic phantom imaged with a conventional CT scanner and Ultra-High Resolution CT in 3 different scan modes (Normal Resolution, High Resolution, Super High Resolution).

Conventional CT
(512 matrix)



NR
(512 matrix)



HR
(1024 matrix)



SHR
(1024 matrix)

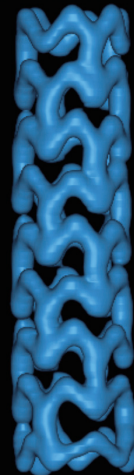

Photo

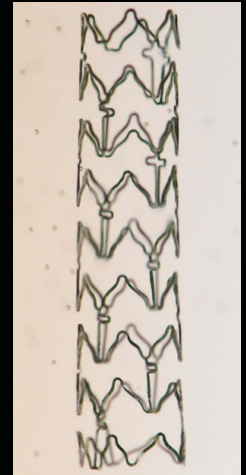

Aquilion Precision

Canon

CANON MEDICAL SYSTEMS USA, INC.

Made For life